



Press **PLAY** to enter the Analog Audio setup page. The page hereunder will be shown:



- Set sound mix output mode:
- press the **▶ RIGHT** arrow to enter the sub-menu. If you want analog stereo signals, set the sound mode to "STEREO", press the **▼ DOWN** arrow once to move the selection to "STEREO", then press **PLAY**.
 - If you want to have Dolby Pro Logic stereo (the decoded signal will create a 2ch reality simulating effect via the R/L connectors), select "LT/RT", then press **PLAY**.

You can select one of these modes to adjust the Bass and Treble signal to your best liking. ON will switch the selected mode on and OFF will switch it back to normal Audio playback. Note: Please be advised that sometimes the BASS on an Audio CD or DVD is already very low, using the Bass Boost or Super Bass can overload your speakers resulting in poor sound quality.

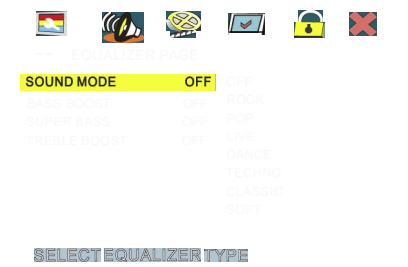

EQUALIZER Select this menu item to set up your preferred Equalizer mode. Press **PLAY** to enter this selection.

You can select one of these preset Equalizer modes to adjust the audio signal to your best liking.

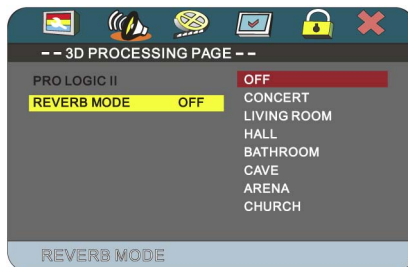

Select **3D PROCESSING** to set up your preferred 3D mode. Press **PLAY** to enter this selection and to set up your preferred Audio mode for a better surround effect. Press **PLAY/SAVE** or the **RIGHT** arrow to enter this selection.

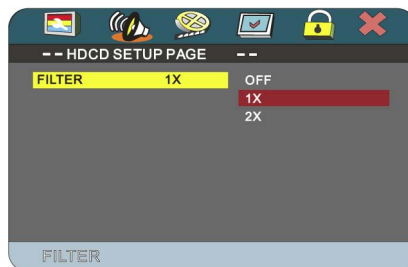

Select **HDCD** to set up your preferred Audio mode for HDCD. Press **PLAY** to enter this selection and to set up your preferred filter mode for HDCD (default is 1X).
1x = 48K Sampling, 2x = 96K Sampling

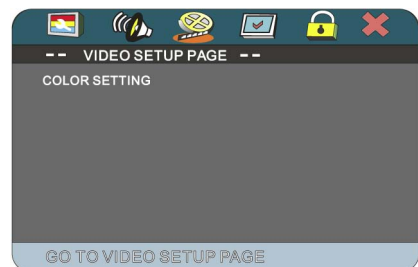

Select this menu item to setup your Video Quality modes. Press **PLAY** to enter this selection.

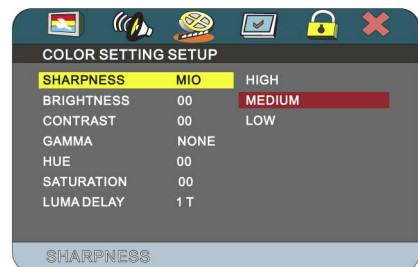

You can set the picture sharpness to these choices. If a video image is light, select the **LOW** option. If a video image is dark, select the **HIGH** option.



You can set the Brightness to your liking. Press PLAY or the ► **RIGHT** arrow to enter the brightness control, then press the ▲ **UP** or ▼ **DOWN** arrow to adjust the image. Press the ◀ **LEFT** arrow to go back to the menu.

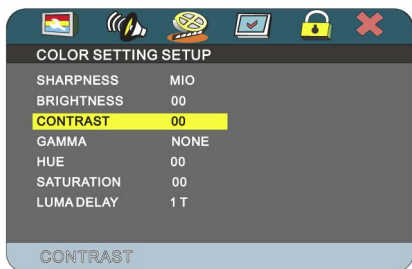

You can set the Contrast to your liking. Press PLAY or the ► **RIGHT** arrow to enter the brightness control, then press the ▲ **UP** or ▼ **DOWN** arrow to adjust the image. Press the ◀ **LEFT** arrow to go back to the menu.

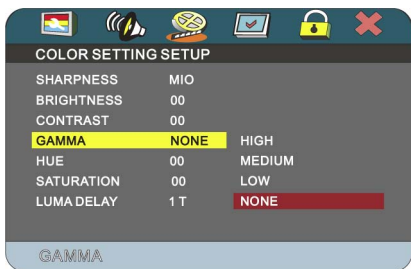

Gamma refers to the exponent between video or pixel values and the displayed brightness. You can set the Gamma to these choices and your liking.

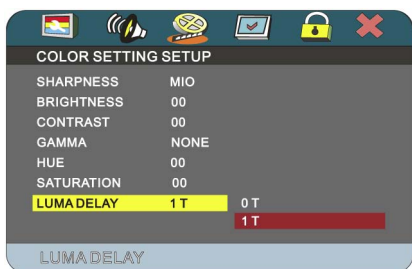

Luma Delay You can adjust the luminance delay by selecting one of these choices to best suit the brightness of your TV.

When playing a DVD disc and you have selected ON, then the screen will show the angle mark. This will give you the possibility to view multi angle DVD's. (whether this functions works, depends on the disc type in use.) When you have selected OFF, no angle mark will be shown on the screen.

To select the language for your On Screen Display (OSD) use this menu item. There are multiple languages available.

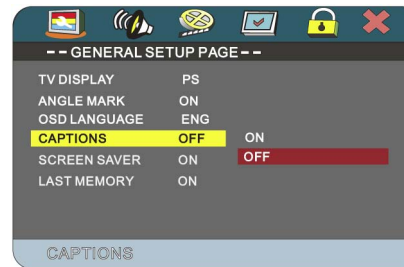

ON: To display captions. (Subtitles)
OFF: Captions will not be displayed. (No Subtitles)

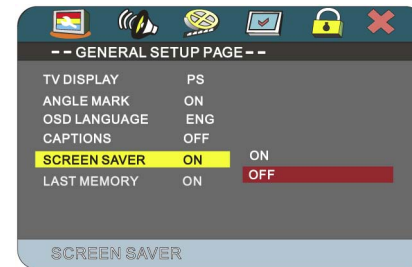

When there is no activity with the Player for some time, a screen saver will start to prevent damage to the screen. Select ON to activate the screen saver function or select OFF to deactivate this function.

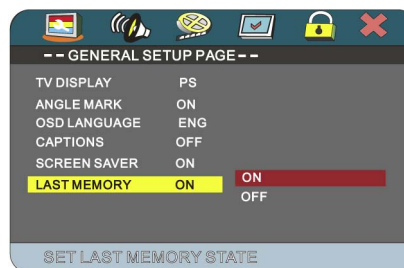

ON: Each time when you turn off the player, it will memorize the last play time. So if you turn on the player the next time and the same disc is played, it will resume play from the last memory point.

OFF: Disable the last memory function



4:3LB Allow you to see movies in their original aspect ratio. The entire frame of the movie will be displayed. 16:9 recorded movies will occupy a smaller portion of the screen and you will see black margins above and below the picture.



4:3PS The movie will be shown full screen without any black margins, but parts of the image will be cut off from the right and left side.



16:9 Allow you to see movies in their original aspect ratio, when connected to a wide screen TV. The entire frame of the movie will be displayed.



16:9 Note: depending the DVD screen format (e.g. 2.35 :1), the wide screen setting may still have black margins above and below the picture.

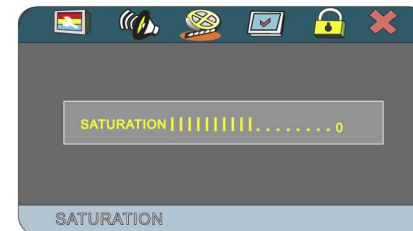
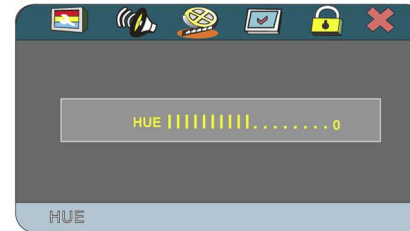
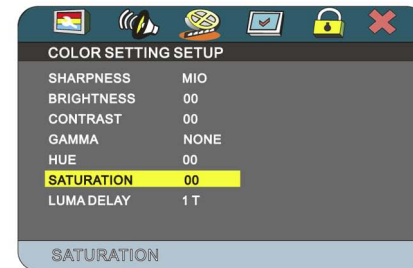
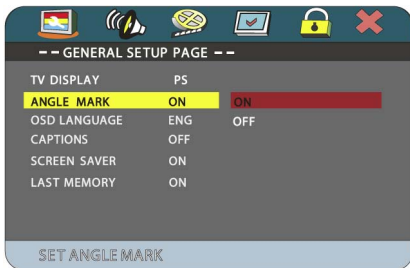

You can set the Hue (for NTSC) to your liking. Press **PLAY/SAVE** or the **▶ RIGHT** arrow to enter the Hue control, then press the **▲ UP** or **▼ DOWN** arrow to adjust the image. Press the **▶ LEFT** arrow to go back to the menu.

You can set the Saturation to your liking. Press **PLAY/SAVE** or the **▶ RIGHT** arrow to enter the Saturation control, then press the **▲ UP** or **▼ DOWN** arrow to adjust the image. Press the **▶ LEFT** arrow to go back to the menu.

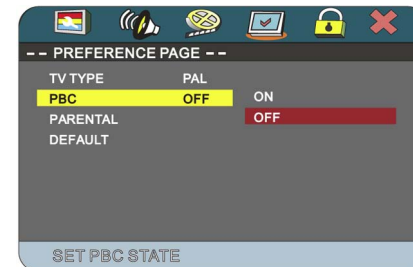
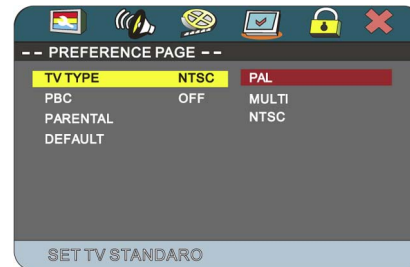

Select this menu item to setup your preferred video output format. PAL is commonly used in Europe and NTSC is commonly used in the USA and Japan. Select **MULTI** only if your TV supports both formats, the output signal will follow automatically the video format on the DVD disc.

For VCD and SVCD, this selection turns **ON** or **OFF** the Playback Control (PSC) function. VCD or SVCD media have PSC menu's that contains the track list. The default PSC state is set to **ON**. In **OFF** mode, no tracks can be selected.

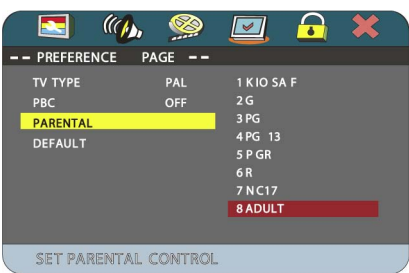

Set age control grade:

For DVD discs with a rating system programmed (for example: the North American CARA) parents can prohibit watching content that might be inadvisable for children. Press the ► RIGHT arrow to enter the submenu. If you want to change the age control grade press either the ▲ UP or ▼ DOWN arrow to scroll to the available selections. Selection 1 is Kid safe, selection 2 is some guidance advisable, selection 3 is PG (Parental guidance suggested, some material may not be suitable for children), selection 4 is PG13 (Parents strongly cautioned, some material may be inappropriate for children under 13), selection 5 is PG-R (Restricted, under 17 requires accompanying parent or adult guardian), selection 6 is Restricted viewing, selection 7 is NC-17 (No one 17 and under admitted), selection 8 is for Adult Entertainment or X rated movies and NO PARENTAL is for General Audiences (All Ages).

Hereafter a screen will indicate to enter a password, if the ex-factory password has never been modified, you can use [123456] by pressing the according number buttons on the remote control. Select "YES" or "NO" with either the left or the right arrow key and press PLAY to confirm.



With this option you can select to reset to the factory preset values.

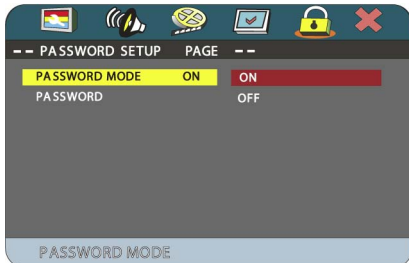

With this option you can select to set your password protection ON or OFF.



Use this menu to change the factory set password [123456]

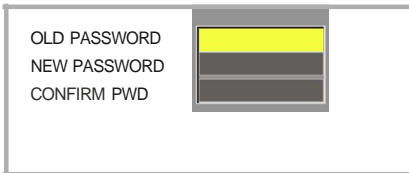

When you press SETUP on the panel or on the remote control, the screen will display setup menu.

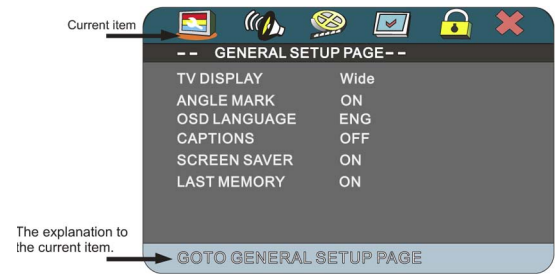

On the RemoteControl, press either the ▲ UP or ▼ DOWN or ◀ LEFT or ▶ RIGHT arrow buttons to move to the desired menu item and press PLAY to select the menu item

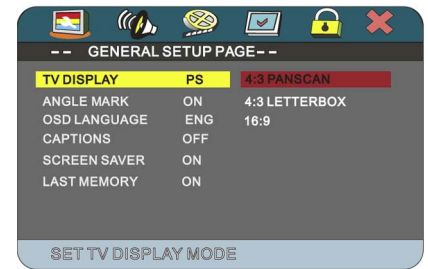

Set TV Display mode to the correct ratio:

- Press the ► RIGHT arrow button to enter the sub-menu. If you want to set the screen to "WIDE", press the ▼ DOWN arrow twice to move your selection until the "WIDE" item is selected, now press PLAY.
- Press SETUP to exit these system settings

Note: three screen ratio modes are available, 16:9 WIDE, 4:3LB (Letterbox) and 4:3PS (Pan Scan). Different disc formats will display different images depending on this setting and the screen size used. Hereunder is an example of the different choices and the relation between the disc format and screen ratio of the different choices and the relation

When you press LANGUAGE on the panel, the screen will display the different types of OSD languages, you can then select the desired OSD language.

When you press DVD on the panel, the screen will display as below and you can adjust the parameters.

Attention:(in DVD state, this item function use to A1280,A1281 no use)

When you press P1/3 on the panel, the screen will display as below



When you press P2/3 on the panel,(NOTE:When you press MUTE, speaker and IR headphone will be muted.When you press POWER on the panel shortly,the speaker will be muted only,and when you press POWER on the panel for two seconds,it will power off)

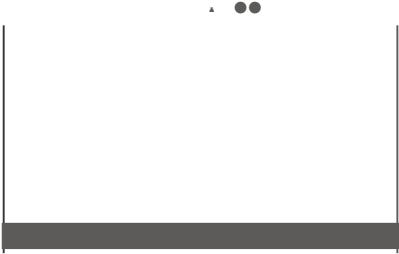

When you press P3/3 on the panel, the screen will display as below:

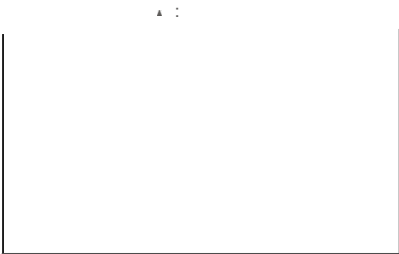

Enter the PIN numbers with the number buttons of the remote control and press PLAY, enter the new password and press PLAY again, confirm your new password and press PLAY again.

Important: Do not forget the newly entered password, there is no way to retrieve the (newly) entered password.

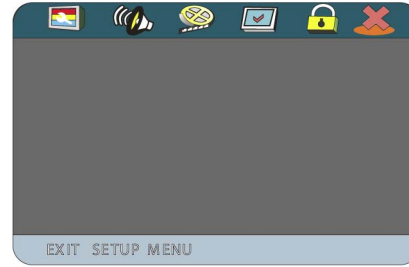

With this selection X you exit the system setup and return to normal viewing of the video.

The Multimedia Player is able to play discs (CD-R / CD-RW) recorded with MP3 / MPEG4 audio and video files. When a disc with MP3 or MPEG4 files (including multiple directories) is loaded in the system the following screen is displayed:

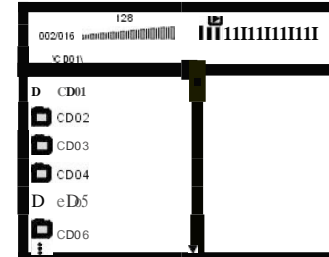

To go to the preferred music or video directory, press the ▲▼ arrows to scroll to your selection and confirm your choice by pressing the PLAY button. To select your preferred song or video title, press the ▲▼ arrows to scroll to your selection and confirm your choice by pressing the PLAY button. Your selected song or video will now be played.

Play mode

There are four kinds of play modes available when playing MP3 / MPEG4(A VI) recorded discs:

- 1) SINGLE (All the songs / videos will be played only once)
- 2) REPEAT ONE (The current playing song / video will be repeated)
- 3) REPEAT FOLDER (Only the songs / videos of the current folder will be repeated)
- 4) FOLDER (Only all the *songs* / videos of this folder will be played once)
- 5) SHUFFLE / RANDOM (The songs / videos will be played in random order)

When the disc is playing, press REPEAT to select your repeat mode, the TV screen will show:

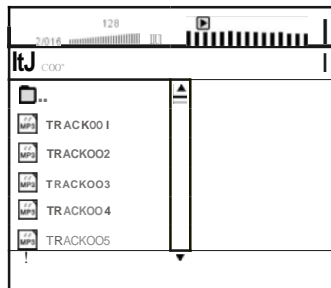

Other functions

Functions such as MUTE, VOLUME, PAUSE, PREVIOUS, NEXT, etc. are also available for MP31 MPEG4 recorded discs. These operations are the same as playing an Audio CD.

After you connect the power wire, press the POWER button on the screen or touch any area of the panel to power on the screen. When you touch any area of the panel, the screen will display as below:
 When you press MONITOR In 1 on the panel, the AV source will shift to Av1
 When you press MONITOR In 2 on the panel, the AV source will shift to Av2



When you select MENU on the panel, the screen will display as below and you can adjust the parameters at your willing

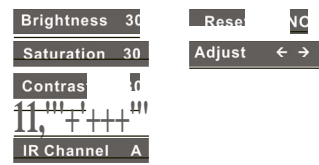

When you press AVSOURCE on the panel, the screen will display as below and you can adjust two monitor parameters at your will.
 When using the A 1280, press AV SOURCE to switch to AUX, press it again and it will switch to DVD

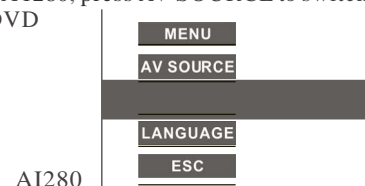

When you press SETUP on the panel, the screen will display as below and you can adjust two monitor parameters at your will; when you select DVD, it will display 1.1

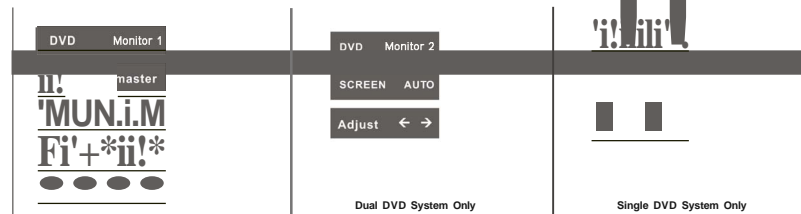

AI280

A 1280I.1

A 1281

The IR Remote Control

Point the remote control no more than about 3~4 meters (approx. 9 feet) from the remote control sensor on the front of the player and keep with in a $\pm 30^\circ$ angle.

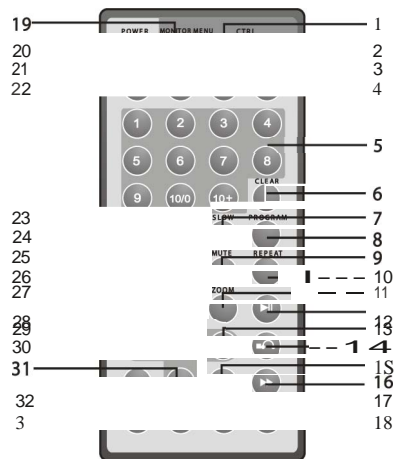

- (1) Adjust Decrease
- (2) Adjust Increase
- (3) Title
- (4) SD
- (5) Number buttons
- (6) Clear
- (7) Slow
- (8) Program
- (9) Mute
- (10) Repeat
- (11) Zoom
- (12) play/pause

- (13) Right Arrow
- (14) Stop&Return
- (15) Fast Reverse
- (16) Fast Forward
- (17) Previous
- (18) Next
- (19) Monitor Menu
- (20) Power
- (21) Menu/PBC
- (22) Source
- (23) Subtitle
- (24) Display

- (25) Audio
- (26) ANGLE
- (27) Up Arrow
- (28) Setup
- (29) Enter
- (30) Left Arrow
- (31) Down Arrow
- (32) Volume+
- (33) Volume-

Package Contents

Check for the following accessories:



HEADREST *WI* DVD MONITOR (2)



REMOTE CONTROL(1)

OWNERS MANUAL(1)

INSTALLATION MANUAL(1)



CONNECT CABLE (2)



AVBOX (1)



AV BOX POWER HARNESS (1)



Headphones (2)

Warning

CAUTION

1. The driver must not be able to view operational monitor while driving the vehicle. This is illegal in most states. CHECK with your local law enforcement officials for details .
2. Always check polarity when connecting wire to avoid damage to the unit and for vehicle.
3. Do not open the housing of the monitor , Servicing must be done at our factory by authorized technicians to maintain the warranty.

Specifications

System	NTSC/PAL Auto Switch
Power Input/Consumption	DC(10.8-16V) ±100/0 , <2500mA
Video Input	Composite Video Signal 1Vp-p 750hm
Operating Temperature	-10°C ~ +60°C
Storage Temperature	-20°C ~ +70°C
Screen Size(Diagonal)	7.0"
Display Method	TFT Active Matrix System
Resolution(Dot)	1440(W)x234(H)
Back Light	CCFL
Viewing Area	154.08(W)x86.58(H)mm
Viewing Angle	Left ,Right:65 ° , Top:40 ° ,Down:65°
Monitor Overall Dimension	164.9(W)x100(H)x5.7(D)mm
Monitor Weight	<1kg
The Specifications are subject to change without prior notice	

Single DVD System Cable Connections

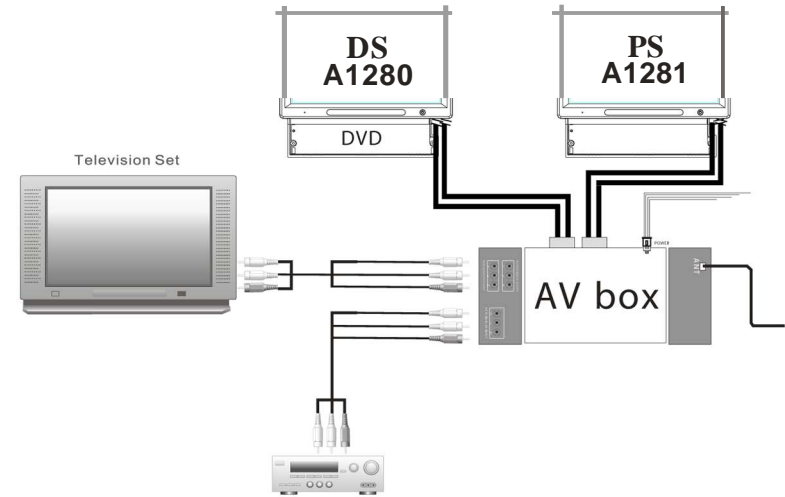

Dual DVD Systems Cable Connections

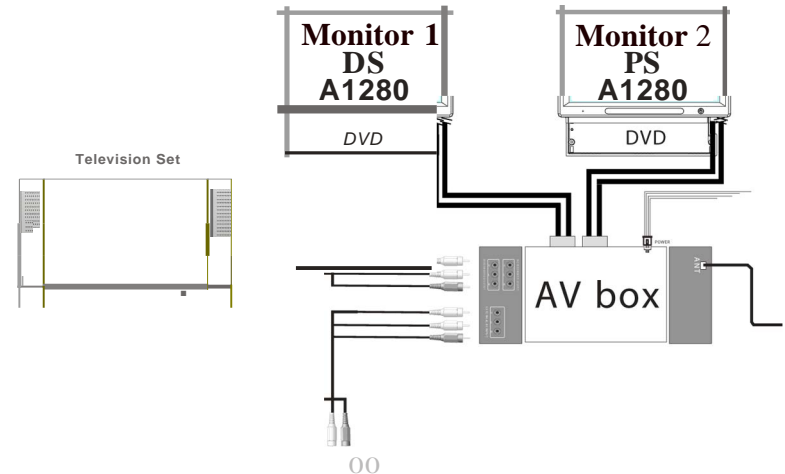

Single & Dual DVD Systems

AI280

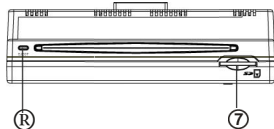
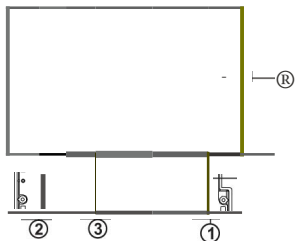

- (1) Power
- (2) Indicator light
when the machine have electric,
it as red light,playing it turnoff
- (3) (8)Infra-Red Audio transmitter:
2.3MHz/2.8MHz & 3.2MHz/3.8MHz
- (4) DVD
- (5) LCD screen
- (6)EJECT
- (7)8D Card

Some DVD discs may have special requirements for playing, with which this system may not be compatible. Please refer to the specifications on the individual disc.

DISC TYPE	Content	Size	Total Play time
DVD	AUDIO/ VIDEO	12CM	About 4.7 GB - 2hrs. (Single side & single layer)
			About 8.5 GB - 4hrs. (Single side & double layer)
			About 9.4 GB - 4hrs. (Double side & Single layer)
			About 17GB - 8hrs. (Double side & double layer)
CD-DA	AUDIO	12CM	About 700MB - 74 minutes
MP3	MP3 AUDIO	12CM	About 700MB - 300 minutes

Discs types

The Multimedia Player can play the following types of discs: DVD / CD / CD-R / CD-RW / DVD-R / DVD-R W / DVD+R / DVD+RW. Discs other than listed above cannot be played. Please do NOT play discs smaller than 12CM or of odd shapes, only play sound 12CM discs.

The Multimedia Player uses the NTSC/PAL color systems. It can not play discs recorded with other systems, such as SECAM.

Region code

The region code for this player is 0 which indicate any region.

Copyright

According to the related laws, DVD discs, without proper authorization, are not allowed to be copied, broadcasted, cable broadcasted, or played publicly with the Multimedia Player.

The Multimedia Player incorporates copyright protection technology that is protected by method of claims of certain U.S. patents and other intellectual Property Rights owned by their rights owners. Reverse engineering or disassembly is prohibited.

Single DVD System Only

A1281

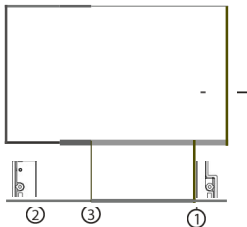

- (1) Power
- (2) Indicator light
when the unit has power, a red light illuminates
- (3) (8)Infra-Red Audio transmitter:
2.3MHz/2.8MHz & 3.2MHz/3.8MHz
- (4) LCD screen

How to hold disc

Do not touch the unlabeled side of the disc..

When there are stains on face of disc

Wipe gently with a wet cloth and then with dry one.

When a disc is brought in from a cold environment to a hot one, condensation can form on the face of the disc. Wipe down with a soft, smooth, dry cloth before using.

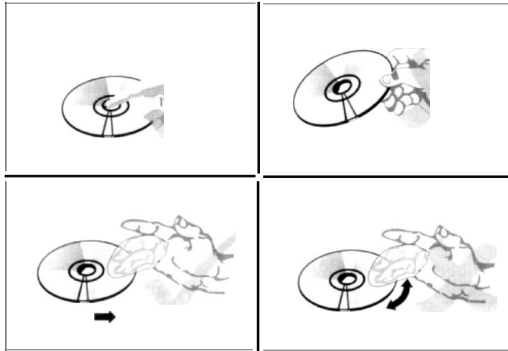

Attention:

- Do not write on the unlabeled side of the disc.
- Do not use chemical solutions to clean the DVD disc.
- Do not stick labels or glue-based notes on the disc.
- Do not use disks with glue residue or damaged labels.
- Do not use anti-scratching materials or covers, that were not designed for this machine.
- Do not put or store disk in the following environments:
Directly under the sunlight, in moist or dusty environments or beside heating elements.

Disc loading

- Load one disc with the data side facing upwards and make sure you do not touch the data side with your fingers.



Once the disc is loaded, the unit will automatically start reading the disk and it will take a few seconds to download the disc initial data, thereafter the disc type will be displayed in the left upper corner of the LCD screen and the unit will start playing the disc.

Dear Customer:

We thank you for purchasing Roadtrip. We wish you many pleasant hours of watching DVD's or listening to your favorite music. Personal Safety has been taken in consideration in the design and manufacturing of this product, however any improper use or operation may result in an electrical shock, fire and/or any other hazards. To prevent these hazards it is strongly recommended to read this manual thoroughly and adhere to the following precautions:

CAUTION: RISK OF ELECTRIC SHOCK

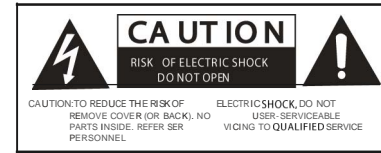

The lightning flash with arrowhead symbol within an equilateral triangle is intended to alert the user to the presence of uninsulated dangerous voltage within the product's enclosure that may be of sufficient magnitude to constitute a risk of electric shock to persons.



The exclamation point within an equilateral triangle is intended to alert the user to the presence of important operating and maintenance (servicing) instructions in the literature accompanying the appliance.

CAUTION:

The unit employs a laser system.

To ensure proper use of this product. Please read this owner's manual carefully and retain for future reference. Should the require maintenance, contact an authorized service location-see service procedure.

Use of controls, adjustments or the performance of procedures other than those specified herein may result in hazardous radiation exposure.

To prevent direct exposure to laser beam, do not try to open the enclosure. Visible laser radiation may be present when the enclosure is opened. Do not stare into beam.

WARNING:

FCC regulations state that any change or modification to the equipment, not expressly approved by maker or its authorized parties, could void user's authority to operate this equipment.

NOTE

Please dispose empty batteries according the regulations in your country. All On Screen Displays (OSD) and Pictures will be based on the English version. Design and Specifications may vary in the manual from the actual product in use.

TABLE OF CONTENTS

Important safety instruction.....	1
Product description.....	2
Connect cable.....	3
The IR Remote Control.....	4
Touch menu.....	5
Setup menu.....	7
Preparation before operation.....	17
Specifications.....	18
Compatible disk types.....	19
How to deal with disc.....	20

VIZUA·LOGIC

A Division of TMI Products, Inc.

Copyright © 2009 TMI Products, Inc.

1493 Bentley Drive • Corona, CA 92879 • 951-272-1996 • 800-624-7960 • Fax 951-272-1584

www.vizualogic.com

DISCLAIMER

FM Modulator Notification for all European Union Vizualogic Customers

Due to E-1 regulations pertaining to FM Modulation in aftermarket mobile electronics products, the following changes have been made for all Vizualogic headrest kits shipped to Europe:

- The systems will be shipped with the default set to FM Modulator OFF.
- The FM Modulators will be inoperable as the antenna has been removed and the antenna receptacle disabled.

VIZUA·LOGIC

*A-1280*ALL-IN-ONE
HEADREST MONITOR/DVD SYSTEM

Owner's Manual